



**SIMPSON**

**Strong-Tie**

®

## DOPORUČENÝ CENÍK ČESKÁ REPUBLIKA

Platný od 01.09.2009

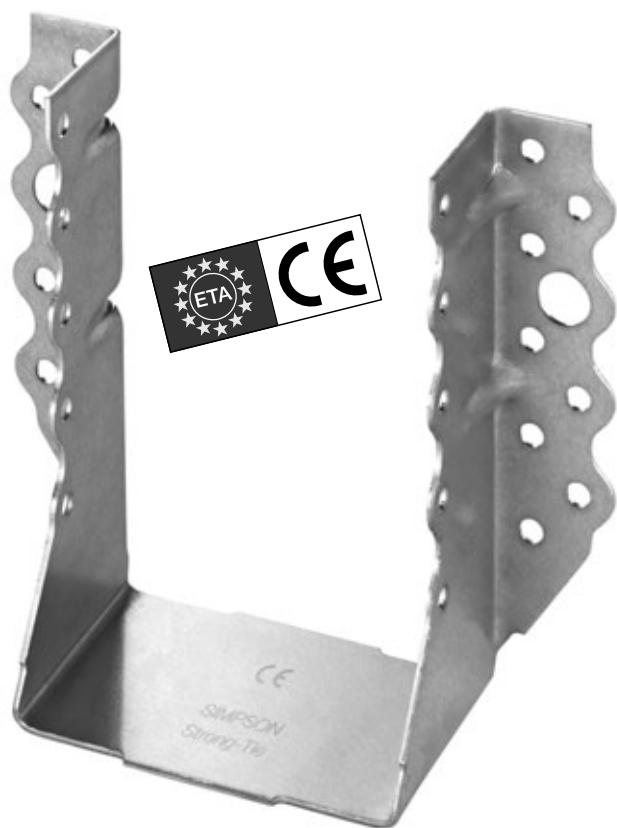

[www.strongtie.eu](http://www.strongtie.eu)  
[www.strongtie.cz](http://www.strongtie.cz)

P-CZ-09-2009



## Obsah P-Z

Patka sloupku JDB.....	24
JGB, JGS.....	25
JIB, JIS.....	25
JPB, JPS.....	25
L, IL.....	25
LB.....	25
LS.....	25
P, PL.....	25
PB, PS.....	26
PDB, PDS.....	26
PGS.....	26
PPA, PPRC.....	26
TB.....	26
U.....	26
VARIO.....	26
PGS Patka sloupku.....	26
Ploché spojky FLV.....	20
Plotové kování CP.....	28
Podlahová spojka (pro terasy), DBT1T.....	28
PPA, PPRC Patka sloupku.....	26
PPJ Sloupkový bodec.....	27
Practilett® Děrované pásy.....	17
Připojky zavětrovací pásy.....	18
Profilová kotva.....	28
<b>S</b>	
SBE Trámová botka.....	9
SBG Trámová botka.....	9-10
Seřizovací náklady pro JANE®-TU/S.....	13
Skrytá trámová spojka.....	12
ALU.....	12
(čtyřřadá).....	12
EL.....	13
EL-S.....	14
ET.....	13
JANE®-TU.....	12
JANE®-TU/S.....	13
Sloupková kotva do betonu.....	27
Sloupková kotva H a HB.....	28
Sloupkový bodec.....	27
PPJ.....	27
SPAX® šrouby.....	32
Spojka plochých úhelníků 66L a 66T.....	5
Spojka vaznice-krokv.....	16
E.....	16
Nerez/INOX.....	29
UNI s natloukacím hrotem.....	16
Spojky paty krokve.....	21
H.....	21
Spojky střešních latí DLV.....	16
SRD/SRC.....	28
Šrouby CSA.....	32
Nerez/INOX (V2A/AISI 304).....	32
SST-hřebíky.....	32
Systém zavětrování 25.....	18
40/60.....	18

## T

Tažná kotva včetně podložky.....	30
Tažná kotva 2-dílné HD2P.....	30
HTT, LTT.....	30
T-Profil ALU.....	14
Trámová botka.....	7-8
BSD.....	10-11
BSDI.....	11
Dělená.....	10
GSE.....	10
I.....	8
IL.....	11
Nerez/INOX.....	29
S.....	11-12
SBE.....	9
SBG.....	9-10
Tvarovky EWP bez montážního ramene.....	15
Tvarovky EWP pro nakloněné a šikmé připojky.....	15
Tvarovky EWP s montážním ramenem.....	15

## U



Úchytka hřebenové latě.....	16
Úhelník.....	4
FLVW.....	5
KR.....	6
Nerez/INOX.....	29
z Ploché spojky.....	5
z Děrované styčnickové plechy 2,0 mm.....	5
z Děrované styčnickové plechy 2,5 mm.....	5
Úhelník kotevní do betonu.....	6
Úhelník pro kulatinu (oblý).....	6
Úhelník schodový TA.....	28
Úhelníky do židlí EC.....	6
U-kotva.....	27
Universální spojka.....	16
U-podložka, žárově zinkované.....	33



## V



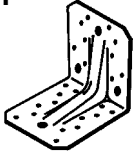

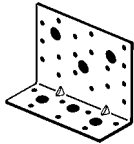
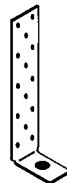
Vrtací šablona.....	15
Vtlačitelný hmoždík GEKA, oboustranné ozubení..	35
jednostranné ozubení.....	35

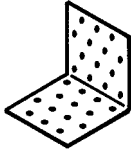
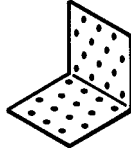
## Z

Základní deska kotvy tvaru U.....	27
Zavětrovací pásy.....	17
Nerez/INOX.....	29

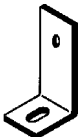
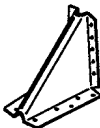

	Art. No.		CZK/ks	ks/bal.	kg/ks
 <p>105 se žebrem</p>	<b>Úhelník</b>				
	07090 00	90 se žebrem	16,64	50	0,210
	07091 00	90 bez žebra	16,64	100	0,200
	07092 00	90 bez žebra 135°	36,40	1	0,210
	07105 00	105 se žebrem	34,58	50	0,400
	ABR9015	ABR9015 (NOVINKA)	25,48	100	0,110
	ABR9020	ABR9020 se žebrem (NOVINKA)	25,74	50	0,168
	ABR105/13	105 se žebrem (Otvor Ø13)	49,66	50	0,400
	E20/3	170x110x3,0x95	91,26	25	0,580
	07106 01	105 bez žebra	34,58	50	0,400
07107 00	105 bez žebra 135°	59,80	1	0,400	
 <p>60280</p>	07070 00	70 se žebrem	14,82	100	0,110
	07071 01	70 bez žebra	14,82	100	0,110
	07690 01	6090	31,20	100	0,160
	07691 01	6191	31,98	100	0,160
	07692 01	6292	32,50	100	0,160
	07635 00	6035	21,06	100	0,100
	07680 01	60280	19,24	100	0,080
	07390 01	40390	27,30	100	0,160
	AC35350	35350	12,48	100	0,048
	07365 01	55365	26,78	100	0,150
 <p>90x48x3x116</p>	07048 01	90x48x3,0x48	30,94	100	0,130
	07076 01	90x48x3,0x76	46,54	100	0,210
	07116 01	90x48x3,0x116	68,64	50	0,340
	07265 01	90265	35,62	100	0,170
	07312 01	40312	39,00	100	0,180
	07412 01	40412	49,14	50	0,240
	07314 00	40314	41,86	50	0,210
	07414 01	40414	53,30	50	0,280
	07035 01	90x35x2,5x40	21,58	100	0,100
	07050 01	160x50x3,0x40	45,24	100	0,180
 <p>AH190 50/2</p>	AH19050/2	AH19050/2	35,10	100	0,150
	AH29050/2	AH29050/2	47,32	50	0,210
	AH39050/2	AH39050/2	44,98	25	0,280
	AH49050/2	AH49050/2	54,34	25	0,340
	AH61050/2	AH61050/2	67,60	25	0,420
	AH19050/4	AH19050/4	53,56	50	0,300
	AH29050/4	AH29050/4	76,70	25	0,420
	AH39050/4	AH39050/4	99,32	25	0,550
	AH49050/4	AH49050/4	121,16	25	0,680
	AH61050/4	AH61050/4	150,28	25	0,830
	07060 01	60416	82,16	50	0,430
	07080 01	80416	111,02	25	0,590
	07099 01	99416	132,08	25	0,720
	07615 00	33x61x1,5x180	88,14	50	0,203
	EFIXR553	EFIXR553	9,36	150	0,040

	Art. No.		CZK/ks	ks/bal.	kg/ks
<b>1</b> 	<b>Úhelník (Děrované styčnickové plechy) 2,0 mm</b>				
	30001 01	40x40x2,0x25	8,58	200	0,030
	30444 01	40x40x2,0x40	10,14	200	0,050
	30446 00	40x40x2,0x60	9,88	200	0,070
	30003 01	40x60x2,0x25	10,14	200	0,040
	30005 01	60x60x2,0x25	10,14	200	0,050
	30664 01	60x60x2,0x40	10,92	100	0,070
	30665 00	60x60x2,0x50	12,22	150	0,090
	30666 00	60x60x2,0x60	12,74	100	0,110
	30668 01	60x60x2,0x80	18,98	100	0,140
	30886 00	80x80x2,0x60	18,72	100	0,140
30888 01	80x80x2,0x80	22,88	50	0,190	
<b>1</b> 	<b>Úhelník (Děrované styčnickové plechy) 2,5 mm</b>				
	08444 01	40x40x2,5x40	20,28	200	0,060
	08446 01	40x40x2,5x60	17,68	200	0,090
	08466 01	40x60x2,5x60	22,36	150	0,110
	08664 01	60x60x2,5x40	16,90	100	0,090
	08665 01	60x60x2,5x50	18,20	150	0,110
	08666 01	60x60x2,5x60	19,24	100	0,140
	08668 01	60x60x2,5x80	33,80	100	0,180
	08661 01	60x60x2,5x100	41,08	50	0,220
	08686 01	60x80x2,5x60	33,28	100	0,160
	08616 00	60x100x2,5x60	34,84	100	0,180
	08886 01	80x80x2,5x60	24,44	100	0,180
	08888 01	80x80x2,5x80	31,98	50	0,240
	08881 00	80x80x2,5x100	50,70	50	0,300
	08116 01	100x100x2,5x60	42,90	50	0,220
08118 00	100x100x2,5x80	52,52	50	0,300	
08111 01	100x100x2,5x100	55,12	50	0,370	
08121 00	100x200x2,5x100	112,84	25	0,560	
<b>1</b> 	<b>FLVW Úhelník</b>				
	FLVW40/100	FLVW40/100	18,46	100	0,080
	FLVW40/180	FLVW40/180	25,74	100	0,170
	FLVW40/100-135	FLVW40/100-135°	22,10	100	0,080
	FLVW40/180-135	FLVW40/180-135°	28,60	100	0,173
	FLVW55/135-135	FLVW55/135-135°	22,36	100	0,119
<b>1</b> 	<b>66L / 66T</b>				
	66L	66L	33,54	25	0,180
	66T	66T	41,86	25	0,180

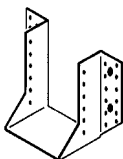
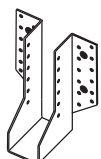
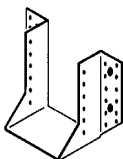

	Art. No.		CZK/ks	ks/bal.	kg/ks
<b>1</b> 	<b>Úhelník KR</b>				
	10050 00	KR 95	76,96	25	0,320
	10055 00	KR 95L	76,96	25	0,320
	10060 00	KR 135	90,74	25	0,400
	10065 00	KR 135L	90,74	25	0,400
	10080 00	KR 285	138,06	25	0,750
	10085 00	KR 285L	138,06	25	0,720
<b>1</b> 	<b>Úhelník kotevní do betonu</b>				
	10010 00	P75x75x6x50 Ø 14	114,40	50	0,300
	10030 00	P100x75x8x60 Ø 14	187,98	25	0,560
	10040 00	P150x75x8x60 Ø 14	249,86	25	0,750
	10041 00	P150x75x8x60 Ø 17,5	249,86	25	0,750
	10020 00	S100x50x8x50 Ø 11	146,38	50	0,410
	10021 00	S100x50x8x50 Ø 14	146,38	50	0,410
<b>1</b> 	<b>Klín</b>				
	19090 00	90	65,52	50	0,300
	19130 00	130	117,00	50	0,440
	19170 00	170	175,50	25	0,730
	19210 00	210	234,00	15	1,070
<b>1</b> 	<b>Úhelník pro kulatinu (oblý)</b>				
	07995 00	60	34,06	100	0,110
	07996 00	80	48,88	100	0,210
<b>1</b> 	<b>CRE Konzolové úhelníky</b>				
	CRE50	CRE50	18,72	150	0,050
	CRE70	CRE70	20,28	150	0,070
	CRE100	CRE100	24,44	100	0,110
	CRE120	CRE120	36,40	50	0,130
	CRE140	CRE140	33,54	50	0,150
	CRE160	CRE160	47,84	50	0,200
	CRE190	CRE190	59,02	50	0,230
	CRE250	CRE250	93,60	50	0,310
	<b>1</b> 	<b>EC Úhelníky do židlí</b>			
EC30/2		EC30/2	8,06	500	0,010
EC40/2		EC40/2	9,36	500	0,020
EC50/2		EC50/2	10,14	500	0,020
EC60/2		EC60/2	6,76	500	0,030
EC70/2,5		EC70/2,5	8,58	200	0,040
EC80/2,5		EC80/2,5	9,88	200	0,050
EC90/3		EC90/3	34,58	200	0,070
EC100/3		EC100/3	37,44	200	0,080
EC120/3		EC120/3	17,16	200	0,100
EC140/3		EC140/3	27,82	200	0,120

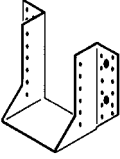
	Art. No.		CZK/ks	ks/bal.	kg/ks
<p><b>2</b></p>   	<b>Trámová botka</b>				
	03202 01	36x142	65,78	50	0,380
	03003 00	40x99	57,98	50	0,250
	03103 01	40x110	53,82	50	0,270
	03203 00	40x140	65,78	50	0,380
	03006 01	45x96	57,98	50	0,250
	03106 01	45x105	53,82	50	0,270
	03204 01	45x137	65,78	50	0,380
	03301 01	45x167	81,64	40	0,430
	03402 01	45x197	108,94	25	0,580
	03007 01	48x95	57,98	50	0,250
	03205 01	48x136	65,78	50	0,380
	03302 01	48x166	81,64	40	0,430
	03501 00	48x226	119,86	25	0,650
	03009 01	51x93	57,98	50	0,250
	03109 01	51x105	39,78	50	0,270
	03206 01	51x135	47,58	50	0,380
	03303 01	51x164	59,02	40	0,430
	03403 01	51x195	106,60	25	0,580
	03112 00	60x100	33,54	50	0,270
	03209 00	60x130	65,78	50	0,380
	03306 00	60x160	55,64	40	0,430
	03406 00	60x190	106,60	25	0,580
	03503 00	60x220	119,86	25	0,650
	03115 01	64x98	55,12	50	0,270
	03212 00	64x128	65,78	50	0,380
	03215 01	70x125	67,60	50	0,380
	03307 00	70x155	81,64	40	0,430
	03216 01	73x124	65,78	50	0,380
	03308 01	73x153	83,46	40	0,430
	03408 00	73x183	106,60	25	0,580
	03218 01	76x120	65,78	50	0,380
	03309 01	76x152	81,64	40	0,430
03221 00	80x120	35,88	50	0,380	
03312 01	80x150	57,20	40	0,430	
03412 00	80x180	74,10	25	0,580	
03506 00	80x210	119,86	25	0,650	
03315 01	90x145	56,68	40	0,430	
03317 01	98x141	81,64	40	0,430	
03224 01	100x90	65,78	50	0,340	
03318 00	100x140	43,68	40	0,430	
03415 00	100x170	106,60	25	0,580	
03509 00	100x200	119,86	25	0,650	

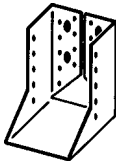
(pokračuje)

	Art. No.		CZK/ks	ks/bal.	kg/ks
<b>2</b> (Pokračování)  	<b>Trámová botka</b>				
	03418 00	115x162	106,60	25	0,580
	03512 00	115x190	119,86	25	0,650
	03612 00	120x119	81,64	25	0,470
	03421 00	120x160	60,58	25	0,580
	03515 00	120x190	119,86	25	0,650
	03518 00	127x186	119,86	25	0,650
	03714 00	140x139	106,60	25	0,540
	03521 00	140x180	67,08	25	0,650
	03424 00	150x145	173,94	25	0,550
<b>2</b>    	<b>Trámová botka I (s rameny ohnutými dovnitř)</b>				
	04103 00	40x110 l	66,30	50	0,250
	04006 01	45x96 l	64,48	50	0,200
	04003 01	48x95 l	64,48	50	0,200
	04205 01	48x136 l	78,26	50	0,320
	04302 01	48x166 l	95,94	40	0,370
	04112 00	60x100 l	52,78	50	0,260
	04306 00	60x160 l	91,26	40	0,390
	04115 00	64x98 l	59,28	50	0,260
	04212 00	64x128 l	65,78	50	0,340
	04215 00	70x125 l	73,84	50	0,340
	04216 01	73x124 l	73,84	50	0,340
	04308 00	73x153 l	87,62	40	0,390
	04218 00	76x120 l	65,78	50	0,380
	04221 00	80x120 l	56,16	50	0,380
	04312 00	80x150 l	81,64	40	0,430
	04412 00	80x180 l	106,60	25	0,580
	04506 00	80x210 l	119,86	25	0,650
	04315 00	90x145 l	81,64	40	0,430
	04317 01	98x141 l	81,64	40	0,430
	04224 00	100x90 l	65,78	50	0,340
	04318 00	100x140 l	68,12	40	0,430
	04415 00	100x170 l	106,60	25	0,580
	04509 00	100x200 l	119,86	25	0,650
	04418 00	115x162 l	106,60	25	0,580
	04512 00	115x190 l	119,86	25	0,650
	04612 00	120x119 l	81,64	25	0,470
04421 00	120x160 l	91,52	25	0,580	
04515 00	120x190 l	119,86	25	0,650	
04714 00	140x139 l	106,60	25	0,540	
04521 00	140x180 l	101,66	25	0,650	

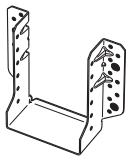

	Art. No.		CZK/ks	ks/bal.	kg/ks
<p><b>2</b></p> 	<b>SBE Trámová botka</b>				
	09010 01	SBE40/95	48,36	70	0,170
	09110 01	SBE40/110	48,36	70	0,200
	09210 01	SBE40/140	57,98	50	0,240
	09013 01	SBE45/93	48,36	70	0,170
	09113 01	SBE45/108	48,36	70	0,200
	09213 01	SBE45/138	57,98	50	0,240
	09313 01	SBE45/168	71,76	30	0,290
	09016 01	SBE48/91	48,36	70	0,170
	09216 01	SBE48/136	57,98	50	0,240
	09316 01	SBE48/166	71,76	30	0,290
	09019 01	SBE51/90	48,36	70	0,170
	09219 01	SBE51/135	57,98	50	0,240
	09122 01	SBE60/100	40,04	70	0,200
	09222 01	SBE60/130	57,98	50	0,240
	09322 01	SBE60/160	70,20	30	0,290
	09125 01	SBE64/98	48,36	70	0,200
	09225 01	SBE64/128	57,98	50	0,240
	09228 01	SBE70/125	56,94	50	0,240
	09328 01	SBE70/155	71,76	30	0,290
09331 01	SBE73/154	71,76	30	0,290	
09234 01	SBE76/122	57,98	50	0,240	
09334 01	SBE76/152	71,76	30	0,290	
09237 01	SBE80/120	46,02	50	0,240	
09337 01	SBE80/150	70,20	30	0,290	
09340 01	SBE90/145	71,76	30	0,290	
09343 01	SBE98/141	71,76	30	0,290	
09346 01	SBE100/140	55,38	30	0,290	
<p><b>2</b></p> 	<b>SBG Trámová botka</b>				
	SBG40/110	SBG40/110	44,46	70	0,170
	SBG45/108	SBG45/108	44,46	70	0,170
	SBG45/137	SBG45/137	53,56	50	0,210
	SBG51/105	SBG51/105	44,46	70	0,170
	SBG51/135	SBG51/135	53,56	50	0,210
	SBG51/164	SBG51/164	65,78	30	0,260
	SBG60/100	SBG60/100	34,06	70	0,170
	SBG60/130	SBG60/130	53,56	50	0,210
	SBG60/160	SBG60/160	65,00	30	0,260
	SBG60/190	SBG60/190 (NOVINKA)	68,12	25	0,290
	SBG60/220	SBG60/220 (NOVINKA)	79,82	25	0,330
	SBG70/125	SBG70/125	52,00	50	0,210
	SBG70/155	SBG70/155	65,78	30	0,260

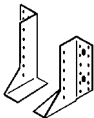
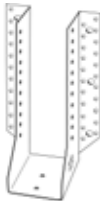
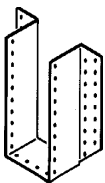

(pokračuje)



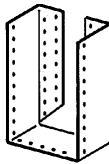
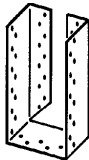
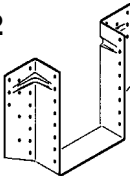

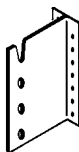
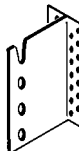
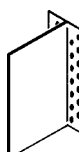
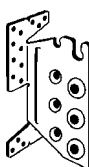
	Art. No.		CZK/ks	ks/bal.	kg/ks
<b>2</b> (Pokračování)	<b>SBG Trámová botka</b>				
	SBG80/120	SBG80/120	38,48	50	0,210
	SBG80/150	SBG80/150	65,00	30	0,260
	SBG80/180	SBG80/180 (NOVINKA)	68,12	25	0,290
	SBG80/210	SBG80/210 (NOVINKA)	79,82	25	0,330
	SBG90/145	SBG90/145	65,78	30	0,260
	SBG100/140	SBG100/140	46,80	30	0,260
	SBG100/170	SBG100/170 (NOVINKA)	68,12	25	0,290
	SBG100/200	SBG100/200 (NOVINKA)	79,82	25	0,330
	SBG120/160	SBG120/160 (NOVINKA)	44,20	25	0,290
SBG120/190	SBG120/190 (NOVINKA)	79,82	25	0,330	
SBG140/180	SBG140/180 (NOVINKA)	51,74	25	0,330	
<b>2</b> 	<b>Trámová botka dělená</b>				
	03010 00	30x98	88,14	20	0,420
	03011 00	30x152	115,18	20	0,430
	03012 00	30x182	140,66	20	0,680
<b>2</b> 	<b>GSE Trámová botka</b>				
	GSE900/120/2,5	GSE (120/390/2,5) (NOVINKA)	378,30	11	1,980
	GSE900/140/2,5	GSE (140/380/2,5) (NOVINKA)	378,30	11	1,980
	GSE960/140/2,5	GSE (140/410/2,5) (NOVINKA)	465,92	10	2,110
	GSE1020/140/2,5	GSE (140/440/2,5) (NOVINKA)	442,78	9	2,240
	GSE900/160/2,5	GSE (160/370/2,5) (NOVINKA)	378,30	11	1,980
	GSE960/160/2,5	GSE (160/400/2,5) (NOVINKA)	465,92	10	2,110
	GSE1020/160/2,5	GSE (160/430/2,5) (NOVINKA)	442,78	9	2,240
<b>2</b> 	<b>BSD Trámová botka</b>				
	BSD80/100	BSD80/100	199,68	50	0,360
	BSD100/120	BSD100/120	218,40	25	0,360
	BSD100/240	BSD100/240	320,58	20	0,740
	BSD120/180	BSD120/180	238,68	25	0,540
	BSD120/240	BSD120/240	278,46	20	0,770
	BSD120/300	BSD120/300	239,20	20	0,830
	BSD120/320	BSD120/320	243,10	20	0,880
	BSD140/200	BSD140/200	247,00	25	0,600
	BSD140/240	BSD140/240	289,64	20	0,830
	BSD140/260	BSD140/260	255,06	25	0,750
	BSD140/300	BSD140/300	263,90	20	0,850
	BSD140/320	BSD140/320	276,38	20	0,900
	BSD160/160	BSD160/160	235,30	25	0,610
	BSD160/200	BSD160/200	254,80	20	0,720
BSD160/240	BSD160/240	320,58	10	0,810	
BSD160/260	BSD160/260	270,92	25	0,760	
BSD160/280	BSD160/280	273,00	10	0,920	

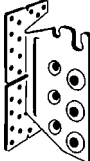

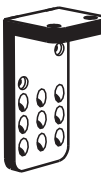

(pokračuje)

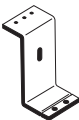



	Art. No.		CZK/ks	ks/bal.	kg/ks	
<b>2</b> (Pokračování)	BSD160/300	BSD160/300	275,60	10	0,970	
	BSD160/320	BSD160/320	439,40	10	1,020	
	BSD180/180	BSD180/180	309,40	20	0,690	
	BSD180/220	BSD180/220	289,64	20	0,790	
	BSD180/280	BSD180/280	427,96	10	0,950	
	BSD180/320	BSD180/320	365,56	20	0,930	
	BSD200/200	BSD200/200	277,42	20	0,770	
	BSD200/240	BSD200/240	357,50	20	0,870	
	BSD200/280	BSD200/280	369,20	20	0,850	
	<b>2</b> 	<b>BSDI Trámová botka</b>				
BSDI80/100		BSDI80/100	232,44	50	0,360	
BSDI120/240		BSDI120/240	307,32	20	0,770	
BSDI140/200		BSDI140/200	289,64	25	0,600	
BSDI140/240		BSDI140/240	319,28	20	0,790	
BSDI140/260		BSDI140/260	280,54	25	0,750	
BSDI140/300		BSDI140/300	306,80	20	0,850	
BSDI160/160		BSDI160/160	260,52	25	0,610	
BSDI160/200		BSDI160/200	280,54	20	0,720	
BSDI160/260		BSDI160/260	293,54	25	0,760	
BSDI160/280		BSDI160/280	302,90	20	0,810	
BSDI160/300		BSDI160/300	312,26	20	0,860	
BSDI180/220		BSDI180/220	319,28	20	0,790	
BSDI200/200		BSDI200/200	307,32	20	0,770	
BSDI200/240	BSDI200/240	395,46	20	0,870		
s rameny ohnutými dovnitř						
<b>2</b> 	<b>Trámová botka IL</b>					
	06200 01	90x195 IL	139,88	25	0,640	
	06202 01	90x235 IL	162,24	25	0,770	
	06206 01	100x190 IL	142,48	25	0,640	
	06210 01	100x230 IL	184,08	25	0,770	
	06204 01	115x223 IL	181,48	25	0,760	
	06208 01	120x180 IL	142,48	25	0,640	
	06212 01	120x220 IL	184,08	25	0,770	
	Typ IL s rameny ohnutými dovnitř					
	<b>2</b> 	<b>Trámová botka S</b>				
05050 00		60x90 S	114,40	25	0,300	
05070 00		60x110 S	127,14	25	0,360	
05100 00		80x110 S	138,06	25	0,370	
05180 00		80x130 S	151,84	25	0,440	
05280 00		80x150 S	164,84	25	0,520	
05240 00		100x130 S	159,90	25	0,450	

	Art. No.		CZK/ks	ks/bal.	kg/ks
2 (Pokračování)	<b>Trámová botka S</b>				
	05330 00	100x150 S	173,16	25	0,500
	05380 00	100x170 S	187,46	25	0,590
	05385 00	100x190 S	200,20	25	0,650
	05430 00	120x170 S	193,96	25	0,590
	05530 00	120x190 S	206,96	25	0,640
	05570 00	120x210 S	224,90	25	0,710
	05630 00	120x230 S	237,90	25	0,780
	05390 00	140x150 S	190,84	25	0,590
	05590 00	160x190 S	227,24	25	0,680
2 	<b>Skrytá trámová spojka</b>				
	34090 00	90	156,78	25	0,520
	34120 00	120	202,28	25	0,670
	34160 00	160	249,86	20	0,900
	34200 00	200	296,40	15	1,120
	34240 00	240	363,22	15	1,350
2 	<b>Skrytá trámová spojka (čtyřřadá)</b>				
	34409 00	90-4	180,44	25	0,540
	34412 00	120-4	221,00	25	0,720
	34416 00	160-4	279,76	20	0,950
	34420 00	200-4	328,38	15	1,180
	34424 00	240-4	390,52	15	1,420
2 	<b>Skrytá trámová spojka ALU</b>				
	34509 00	90 ALU	264,42	25	0,230
	34512 00	120 ALU	317,46	25	0,300
	34516 00	160 ALU	384,28	25	0,410
	34520 00	200 ALU	470,08	15	0,510
	34524 00	240 ALU	582,66	15	0,610
	34503 00	3.000 mm ALU	7330,96	1	7,980
2 	<b>Skrytá trámová spojka - JANE®-TU</b>				
	TU12	JANE-TU 12	154,96	50	0,260
	TU16	JANE-TU 16	191,36	50	0,390
	TU20	JANE-TU 20	241,02	25	0,530
	TU24	JANE-TU 24	303,42	25	0,660
	TU28	JANE-TU 28	352,56	20	0,800



	Art. No.		CZK/ks	ks/bal.	kg/ks
<b>2</b> 	<b>Skrýtá trémová spojka - JANE®-TU/S</b>				
	34312 30	JANE-TU/S 12	247,26	1	0,260
	34316 30	JANE-TU/S 16	303,42	1	0,390
	34320 30	JANE-TU/S 20	364,78	1	0,530
	34324 30	JANE-TU/S 24	438,88	1	0,660
	34328 30	JANE-TU/S 28	506,74	1	0,800
<b>Seřizovací náklady pro JANE®-TU/S</b>					
Seřizovací náklady pro JANE-TU/S se rozumí za každé změření, vyrovnání a požadovaný počet stupňů.			390,00		
<b>2</b> 	<b>Skrýtá trémová spojka ET</b>				
	34709 00	ET90	560,56*	25	0,100
	34712 00	ET120	708,50*	25	0,140
	34716 00	ET160	794,04*	25	0,190
	34719 00	ET190	833,04*	25	0,270
	34723 00	ET230	957,84*	25	0,340
	95580 00	SPAX® šrouby 5x80	1098,24	200	1,450
* jsou prodávány v sadách					
<b>2</b>	<b>Frézovací a montážní šablona pro spojku ET</b>				
	3490300	Montážní šablona pro ET90-230	10920,00	1	3,900
	ETTP90-160	Dřevěná šablona k ET90, ET120 a ET160	2882,88	1	1,040
	ETTP190-230	Dřevěná šablona k ET190-230	4736,16	1	1,460
<b>2</b> 	<b>Skrýtá trémová spojka EL</b>				
	34803 00	EL30	458,12	25	0,120
	34804 00	EL40	554,06	25	0,160
	34806 00	EL60	651,04	25	0,240
	34808 00	EL80	711,36	25	0,320
	34810 00	EL100	793,52	25	0,400
	95570 00	SPAX® šrouby 5x70 (ks/bal.)	960,96	200	1,300
<b>2</b>	<b>Frézovací a montážní šablona pro spojku EL</b>				
	34904 00	Frézovací a montážní šablona pro EL skrytá trémová spojka	12286,56	1	3,350

	Art. No.		CZK/ks	ks/bal.	kg/ks
<b>2</b> 	<b>Skrytá trámová spojka EL-S</b>				
	34823 00	EL-S30	435,76	25	0,140
	34824 00	EL-S40	527,28	25	0,170
	34826 00	EL-S60	625,82	25	0,260
	34828 00	EL-S80	682,76	25	0,350
	34830 00	EL-S100	762,06	25	0,430
<b>2</b> 	<b>ATF</b>				
	34751 00	ATF 55x110	619,32	20	0,420
	34755 00	ATF 55x150	680,16	20	0,570
	34759 00	ATF 55x190	757,64	20	0,710
	34775 00	ATF 75x150	793,00	10	0,790
	34779 00	ATF 75x190	907,66	10	0,990
<b>2</b>	<b>Frézovací a montážní šablona pro spojku ATF</b>				
	34907 00	Frézovací šablona ATF55	2882,88	1	1,450
	34908 00	Frézovací šablona ATF75	2882,88	1	1,400
	34905 00	Montážní šablona ATF55	2882,88	1	1,550
	34906 00	Montážní šablona ATF75	2882,88	1	1,450
<b>2</b> 	<b>BOZETT® SK</b>				
	80740 00	SK176x60	921,18	1	1,000
	80741 00	SK176x80	983,06	1	1,300
	80742 00	SK176x100	1075,88	1	1,700
	80743 00	SK196x60	983,06	1	1,100
	80744 00	SK196x80	1075,88	1	1,400
	80745 00	SK196x100	1143,74	1	1,800
	80746 00	SK216x60	1013,74	1	1,200
	80747 00	SK216x80	1106,56	1	1,500
	80748 00	SK216x100	1174,94	1	1,900
	80749 00	SK236x60	1044,94	1	1,300
	80750 00	SK236x80	1143,74	1	1,600
80751 00	SK236x100	1205,36	1	2,000	
<b>2</b> 	<b>T-Profil ALU</b>				
	34603 00	3000	9988,16	1	10,560
<b>2</b> 	<b>JANEBO® H</b>				
	80614 00	H140	811,46	1	2,100
	80620 00	H200	1007,24	1	2,500
	80626 00	H260	1260,48	1	3,200
	80632 00	H320	1504,62	1	3,700
	80638 00	H380	1790,10	1	4,500

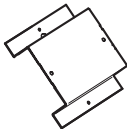
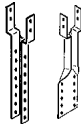
	Art. No.		CZK/ks	ks/bal.	kg/ks
<b>2</b> 	<b>JANEBO® D</b>				
	80601 00	D1-20	1639,56	1	0,800
	80602 00	D1-24	1684,54	1	1,000
	80603 00	D1-36	2202,46	1	1,600
	80604 00	D1-48	2122,90	1	2,300
	80605 00	D1-60	2512,12	1	3,000
<b>2</b>	<b>Vrtací šablona</b>				
	34902 00	Vrtací šablona Ø 8	7207,20	1	1,600
	34901 00	Vrtací šablona Ø 12	13590,72	1	6,600
	BTBS40	BTBS40	946,40	1	1,100
<b>2</b> 	<b>Tvarovky EWP s montážním ramenem</b>				
	ITT359.5	ITT359.5	130,26	25	0,320
	ITT3511.88	ITT3511.88	205,92	25	0,400
<b>2</b> 	<b>Tvarovky EWP bez montážního ramene</b>				
	IUT3510	IUT3510	130,00	50	0,280
	IUT3512	IUT3512	174,72	50	0,340
	IUT3514	IUT3514	203,58	50	0,380
	IUT410	IUT410	162,24	50	0,280
	IUT412	IUT412	138,32	50	0,340
	HU416	HU416	294,58	25	0,760
	<b>2</b> 	<b>Tvarovky EWP pro nakloněné a šikmé přípojky</b>			
LSSUI35		LSSUI35	199,68	25	0,400
LSSU410		LSSU410	262,08	25	0,660
LSTA21		LSTA21	154,18	50	0,120
SUR2.37/11		SUR2.37/11	543,92	20	0,941
SUL2.37/11		SUL 2.37/11	516,88	20	0,940
SUR410		SUR410	612,30	25	0,750
SUL410		SUL410	612,30	25	0,750

	Art. No.		CZK/ks	ks/bal.	kg/ks
<b>3</b> 	<b>Universální spojka</b>				
	01300 00	micro96 levá	25,48	100	0,080
	01301 00	micro96 pravá	25,48	100	0,080
	01200 00	mini100 levá	35,10	100	0,150
	01201 00	mini100 pravá	35,10	100	0,150
	01100 00	midi130 levá	57,98	50	0,240
	01101 00	midi130 pravá	57,98	50	0,240
	01000 00	maxi190 levá	48,36	50	0,200
01002 00	maxi190 pravá	48,36	50	0,200	
<b>3</b> 	<b>Spojka vaznice-krokev</b>				
	02170 01	170 levá	9,88	100	0,100
	02171 01	170 pravá	9,88	100	0,100
	02172 00	170 pravá/levá	9,62*	40 sad	0,100
	02210 01	210 levá	14,56	100	0,130
	02211 01	210 pravá	14,56	100	0,130
	02212 00	210 pravá/levá	13,78*	40 sad	0,130
	02250 01	250 levá	33,80	100	0,170
	02251 01	250 pravá	33,80	100	0,170
	02290 01	290 levá	42,38	100	0,210
	02291 01	290 pravá	42,38	100	0,210
	02330 01	330 levá	61,10	50	0,240
	02331 01	330 pravá	61,10	50	0,240
02370 01	370 levá	75,40	50	0,280	
02371 01	370 pravá	75,40	50	0,280	
* Cena/sadu					
<b>3</b> 	<b>Spojka vaznice-krokev E</b>				
	32170 00	170 pravá/levá	15,08*	40 sad	0,080
	32210 00	210 pravá/levá	21,32*	40 sad	0,110
jsou prodávány v sadách * Cena/sadu					
<b>3</b> 	<b>Spojka vaznice-krokev UNI s natloukacím hrotem</b>				
	32570 00	170	18,46	100	0,080
	32610 01	210	24,44	100	0,090
	32650 00	250	42,12	100	0,110
<b>3</b> 	<b>Spojky střešních latí DLV</b>				
	DLV60/40	DLV60/40	45,76	50	0,220
	DLV60/50	DLV60/50	48,36	50	0,240
	DLV100/40	DLV100/40	53,30	50	0,260
<b>3</b> 	<b>Úchytka hřebenové latě</b>				
	02840 00	1/40	115,44	50	0,120
	02850 00	1/50	115,44	50	0,120
	02800 00	2/50	123,50	50	0,180

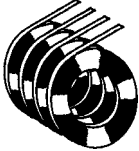

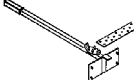
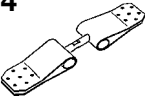

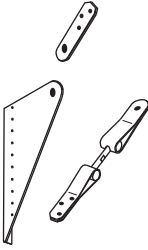
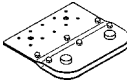
	Art. No.		CZK/ks	ks/bal.	kg/ks
<b>4</b> 	<b>Děrované pásy</b>				
	27103 00	20x1,0 3 m	156,78	10 Rl.	0,420
	27110 00	20x1,0 10 m	397,54	10 Rl.	1,530
	27210 00	20x1,0 25 m	903,24	5 Rl.	3,800
	27115 00	20x1,5 10 m	512,98	10 Rl.	2,290
	27215 00	20x1,5 25 m	1165,32	5 Rl.	5,130
	27120 00	25x2,0 10 m	792,22	4 Rl.	3,980
	27252 00	25x2,0 25 m	1406,08	1 Rl.	9,500
<b>4</b> 	<b>Děrované pásy practilett®</b>				
	27128 00	AR 12x0,8 pozinkování 10 m	293,54	20 Rl.	0,530
	27128 90	AR 12x0,8 černá 10 m	630,24	20 Rl.	0,570
	27128 91	AR 12x0,8 bílá 10 m	630,24	20 Rl.	0,570
	27128 92	AR 12x0,8 červená 10 m	630,24	20 Rl.	0,570
	27178 00	AR 17x0,8 pozinkování 10 m	404,56	20 Rl.	0,780
	27179 00	AR 17x0,8 pozinkování 25 m	735,02	10 Rl.	1,880
	27261 00	AR 26x1,2 pozinkování 10 m	828,62	10 Rl.	1,650
	27168 00	PR 16x0,8 pozinkování 10 m	388,18	20 Rl.	0,800
	27168 90	PR 16x0,8 černá 10 m	832,00	20 Rl.	0,870
	27168 91	PR 16x0,8 bílá 10 m	832,00	20 Rl.	0,870
27168 92	PR 16x0,8 červená 10 m	832,00	20 Rl.	0,870	
<b>4</b> 	<b>Zavětrovací pásy</b>				
	27414 00	40x1,5 25 m	1854,06	1	10,800
	27415 00	40x1,5 50 m	2678,78	1	21,600
	27419 00	40x2,0 25 m	1761,24	1	14,000
	27420 00	40x2,0 50 m	2417,48	1	28,000
	27430 00	40x3,0 50 m	6983,34	1	46,200
	27615 00	60x1,5 50 m	4592,90	1	35,100
	27620 00	60x2,0 50 m	4266,86	1	46,200
	27815 00	80x1,5 25 m	5049,20	1	24,000
	27820 00	80x2,0 25 m	5655,26	1	29,700
<b>4</b> 	<b>Dopínací spojky</b>				
	27000 00	Dopínací spojky	2206,36	3	1,000
	27002 00	Dopínací spojky S	7756,32	1	2,300
<b>4</b> 	<b>Dopínací spojky 25, 40, 60, 80</b>				
	27025 00	25	720,98	4	0,480
	27040 00	40	772,46	4	0,700
	27060 00	60	1018,94	4	1,330
	27080 00	80	1467,96	4	1,780

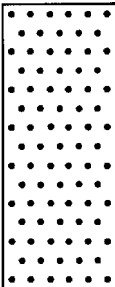
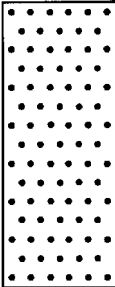
	Art. No.		CZK/ks	ks/bal.	kg/ks
<b>4</b> 	<b>Odvíječka pásu</b>				
	27004 00	Odvíječka pásu s vyrovnáním	31780,32	1	23,500
	27001 00	Odvíječka pásu bez vyrovnání	27181,44	1	21,800
<b>4</b> 	<b>Systém zavětrování 25</b>				
	27920 00	Pásové spojky F 25 r/l včetně kotevních hřebíků	470,08*	2	0,860*
	27923 00	Pásové spojky G 25 r/l včetně kotevních hřebíků	617,50*	2	1,800*
	27926 00	Pásové spojky K 25 včetně kotevních hřebíků	181,48	40	0,290
	27929 00	Vazební spojky 25 včetně šroubů + trnů	253,76	4	0,170
	27030 00	Dopínací spojky B 25 Ø 12 včetně šroubů + trnů	680,42	4	0,530
	27025 00	Dopínací spojky 25 včetně šroubů	720,98	4	0,480
	* cena za sadu				
<b>4</b> 	<b>Systém zavětrování 40/60</b>				
	27940 00	Pásové spojky F 40 r/l	619,06*	2	1,370*
	27943 00	Pásové spojky G 60 r/l	843,70*	2	2,560*
	27946 00	Pásové spojky K 40/60	232,96	10	0,580
	27949 00	Vazební spojky 40/60 včetně šroubů + trnů	315,90	4	0,360
	27050 00	Dopínací spojky B 40/60 Ø 20 včetně šroubů + trnů	1183,78	4	1,600
	27040 00	Dopínací spojky 40 včetně šroubů	772,46	4	0,700
	27060 00	Dopínací spojky 60 včetně šroubů	1018,94	4	1,330
* cena za sadu					
<b>4</b> 	<b>Připojky zavětrovací pásy</b>				
	27950 00	1	1992,12	8	2,130
	27951 00	2	2435,16	8	2,700
	27953 00	Připojení zavětrovací pásy	784,94	8	0,810
	27954 00	Připojení M16	915,72	16	0,550
	27955 00	Připojení M12	915,72	16	0,580

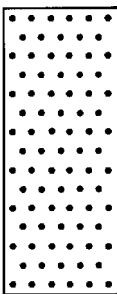
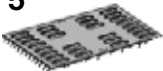

	Art. No.		CZK/ks	ks/bal.	kg/ks
<p><b>5</b></p> 	<b>Děrované styčnickové plechy t = 1,5 mm</b>				
	NP15040120	40x120x1,5	10,66	50	0,050
	NP15040160	40x160x1,5	12,22	50	0,070
	NP15050200	50x200x1,5	16,12	50	0,110
	1552501	60x140x1,5	13,52	50	0,090
	1553001	60x160x1,5 (NOVINKA)	17,94	50	0,104
	1553701	60x200x1,5	18,46	100	0,140
	NP15060240	60x240x1,5	22,10	50	0,160
	1554001	60x300x1,5 (NOVINKA)	31,72	50	0,200
	1553601	60x340x1,5 (NOVINKA)	35,62	50	0,230
	1553801	60x420x1,5 (NOVINKA)	42,12	50	0,280
	1553901	60x500x1,5 (NOVINKA)	52,52	50	0,337
	1554101	80x140x1,5 (NOVINKA)	19,50	50	0,130
	NP15080200	80x200x1,5	29,90	50	0,220
	1554601	80x240x1,5	29,90	50	0,220
	1555001	80x280x1,5 (NOVINKA)	37,70	50	0,250
	1555501	80x300x1,5	39,52	50	0,260
	1556001	80x340x1,5 (NOVINKA)	45,76	50	0,304
	1557101	100x140x1,5	23,14	50	0,160
	NP15100200	100x200x1,5	30,16	50	0,220
	1557201	100x220x1,5 (NOVINKA)	37,18	50	0,240
	1557301	100x240x1,5	40,56	50	0,260
	1557401	100x300x1,5	50,44	50	0,330
	1557601	100x340x1,5 (NOVINKA)	56,94	50	0,370
	NP15120240	120x240x1,5	50,70	50	0,310
	1558201	120x260x1,5	52,00	50	0,340
	NP15120300	120x300x1,5	61,62	25	0,400
1558501	140x200x1,5 (NOVINKA)	47,84	50	0,312	
1559301	140x300x1,5 (NOVINKA)	72,02	25	0,460	
1562001	160x260x1,5 (NOVINKA)	69,68	25	0,452	
NP15160400	160x400x1,5	110,76	20	0,700	
1563101	180x220x1,5 (NOVINKA)	68,12	25	0,440	
<p><b>5</b></p> 	<b>Děrované styčnickové plechy t = 2,0 / 2,5 / 3,0 mm</b>				
	20525 01	40x120x2,0	8,32	50	0,070
	20530 01	40x160x2,0	11,70	50	0,090
	20535 01	50x200x2,0	17,42	50	0,150
	20540 01	60x140x2,0	13,52	50	0,120
	20545 01	60x200x2,0	16,64	50	0,180
	20550 01	60x240x2,0	22,36	50	0,220
	20555 01	80x200x2,0	21,58	50	0,230
	20560 01	80x240x2,0	26,00	50	0,290
	20565 01	80x300x2,0	55,38	50	0,350
	20570 01	100x140x2,0	22,36	50	0,200
	20575 01	100x200x2,0	29,90	50	0,300

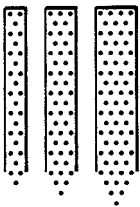

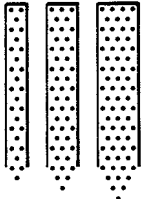
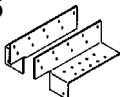
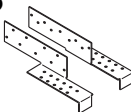
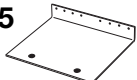
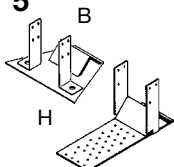

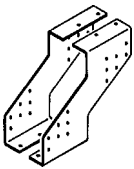
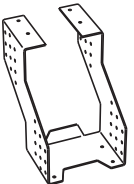
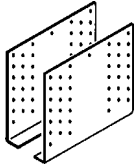

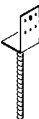
(pokračuje)

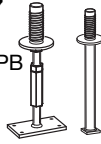
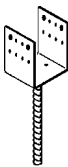
	Art. No.		CZK/ks	ks/bal.	kg/ks
<b>5</b> (Pokračování) 	<b>Děrované styčnickové plechy t = 2,0 / 2,5 / 3,0 mm</b>				
	20580 01	100x240x2,0	39,26	50	0,350
	20585 01	100x260x2,0	43,68	50	0,380
	20590 01	100x300x2,0	71,76	25	0,450
	20592 01	100x400x2,0	118,30	25	0,600
	20594 01	100x500x2,0	98,02	25	0,750
	20595 01	120x200x2,0	39,78	50	0,350
	20600 01	120x240x2,0	70,98	50	0,410
	20605 01	120x260x2,0	51,22	25	0,480
	20610 01	120x300x2,0	50,70	25	0,530
	20614 01	120x400x2,0	78,26	25	0,690
	20615 01	140x400x2,0	164,32	25	0,830
	20612 01	160x300x2,0	105,56	25	0,690
	20617 01	160x400x2,0	110,76	20	0,930
	20620 01	200x300x2,0	169,26	20	0,890
NP20/650/1200	650x1200x2,0	1314,56	1	12,250	
NP25/650/1200	650x1200x2,5	1918,80	1	15,310	
NP30/650/1500	650x1500x3,0	2380,30	1	23,000	
<b>5</b> 	<b>Děrované styčnickové plechy MP</b>				
	MP24	MP24	11,96	100	0,040
	MP36	MP36	22,10	100	0,090
<b>5</b> 	<b>Ploché spojky FLV</b>				
	FLV40/100	FLV40/100	16,12	100	0,080
	FLV40/180	FLV40/180	23,66	100	0,170
	FLV55/135	FLV55/135	19,76	100	0,120
<b>5</b> 	<b>Děrované styčnickové pásy t = 2,0 mm</b>				
	20040 01	40x1200x2,0	130,00	30	0,700
	20060 00	60x1200x2,0	196,30	20	1,050
	20080 00	80x1200x2,0	235,04	15	1,390
	20100 00	100x1200x2,0	282,62	10	1,710
	20120 00	120x1200x2,0	353,08	10	2,070
	20140 00	140x1200x2,0	435,24	10	2,390
	20160 00	160x1200x2,0	486,46	5	2,770
	20180 00	180x1200x2,0	577,98	5	3,110
	20200 00	200x1200x2,0	612,30	5	3,460
	20220 00	220x1200x2,0	696,02	5	3,800
	20240 00	240x1200x2,0	787,54	5	4,150
	20260 00	260x1200x2,0	865,80	5	4,490
	20280 00	280x1200x2,0	921,18	5	4,840
	20300 00	300x1200x2,0	976,30	5	5,180

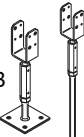
	Art. No.		CZK/ks	ks/bal.	kg/ks
<b>5</b> 	<b>Děrované styčnickové pásy t = 2,5 mm</b>				
	25040 00	40x1200x2,5	180,44	20	0,880
	25060 00	60x1200x2,5	269,88	15	1,320
	25080 00	80x1200x2,5	358,28	10	1,790
	25100 00	100x1200x2,5	442,00	10	2,190
	25120 00	120x1200x2,5	510,64	10	2,610
	25140 00	140x1200x2,5	573,56	5	3,090
	25160 00	160x1200x2,5	663,00	5	3,380
	25180 00	180x1200x2,5	741,78	5	3,970
	25200 00	200x1200x2,5	814,06	5	4,310
	25220 00	220x1200x2,5	904,28	1	4,740
	25240 00	240x1200x2,5	998,66	1	5,260
	25260 00	260x1200x2,5	1074,58	1	5,590
	25280 00	280x1200x2,5	1164,02	1	6,020
25300 00	300x1200x2,5	1233,70	1	6,450	
<b>5</b> 	<b>Spojky paty krokve</b>				
	13001 00	Normal	142,22	25	0,680
	13002 00	Maxi	265,72	10	1,340
jsou prodávány v sadách					
<b>5</b> 	<b>Spojky paty krokve H</b>				
	13003 00	H	127,14	20	0,510
	13004 00	HM	144,82	20	0,620
	13005 00	HS	623,74	10	1,620
jsou prodávány v sadách					
<b>5</b> 	<b>Držáky prahů</b>				
	13014 00	LM	356,98	1	2,830
	13015 00	LS	902,72	1	5,200
<b>5</b> 	<b>Osedlání krokve</b>				
	24080 00	B80	546,52	15	1,230
	24100 00	B100	608,40	15	1,430
	24120 00	B120	682,50	10	1,640
	23080 00	H80	477,10	15	1,240
	23100 00	H100	518,70	10	1,360
	23120 00	H120	580,58	10	1,550

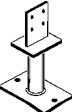

	Art. No.		CZK/ks	ks/bal.	kg/ks
<b>6</b> 	<b>Gerberova spojka B</b>				
	11125 00	125	140,66	25	0,500
	11150 00	150	130,26	25	0,590
	11160 00	160	130,26	25	0,620
	11175 00	175	144,82	25	0,670
	11180 00	180	144,82	25	0,680
	11201 00	200	158,60	25	0,740
	11220 00	220	177,58	25	0,800
jsou prodávány v sadách					
<b>6</b> 	<b>Gerberova spojka G</b>				
	12218 00	120x180	285,22	10	0,790
	12220 00	120x200	295,88	10	0,850
	12222 00	120x220	315,90	10	0,910
	12224 00	120x240	336,18	10	0,970
	12226 00	120x260	*	10	1,020
	12420 00	140x200	*	10	0,880
	12422 00	140x220	*	10	0,940
	12424 00	140x240	346,58	10	0,990
	12426 00	140x260	*	10	1,050
	12622 00	160x220	*	10	0,970
	12624 00	160x240	*	10	1,020
12626 00	160x260	*	10	1,080	
* Cena na požádání					
<b>6</b> 	<b>Gerberova spojka W</b>				
	28090 00	90	109,46	25	0,490
	28120 00	120	205,14	25	0,810
	28140 00	140	231,66	20	0,920
	28160 00	160	250,90	20	1,040
	28180 00	180	284,44	15	1,150
	28200 00	200	312,26	15	1,270
	28220 00	220	335,66	15	1,310
	28240 00	240	370,76	15	1,470
	28260 00	260	399,10	10	1,570
jsou prodávány v sadách					

	Art. No.		CZK/ks	ks/bal.	kg/ks
<b>7</b> 	<b>Patka sloupku A</b>				
	26070 01 26090 01	A70 A90	166 ,40 269,88	25 20	0,600 1,020
<b>7</b> 	<b>Patka sloupku B</b>				
	26091 01 26092 01	B40 B70	187,20 247,26	25 20	0,670 0,930
<b>7</b> BK 	<b>Patka sloupku BK, BL</b>				
	42105 01 42005 00	BK 70x60 BL 70x60	161,98 268,58	25 15	0,630 1,040
<b>7</b> 	<b>Patka sloupku CMR</b>				
	44150 00	CMR	4454,58	1	20,350
<b>7</b> CPB CPS 	<b>Patka sloupku CPB, CPS</b>				
	CPB40 CPS40 BH54	CPB CPS Zaslepovací pouzdro (CPB)	1639,56 1327,82 268,32	5 5 5	4,100 3,600 0,660
<b>7</b> 	<b>Patka sloupku D</b>				
	26484 01 26504 01 26734 01 26104 01	D 48x40 D 50x40 D 73x40 D 100x40	321,88 324,74 336,18 353,08	20 20 20 20	0,850 0,850 0,930 0,980
	26737 01 26757 01 26807 00 26107 01	D 73x70 D 75x70 D 80x70 D 100x70	454,74 454,74 429,78 432,12	15 15 15 10	1,330 1,330 1,330 1,400
	26986 01	D 98x60	424,06	15	1,180
	26909 01 26109 01 26115 01 26120 01 26123 01 26125 00 26140 01 26148 01	D 90x90 D 100x90 D 115x90 D 120x90 D 123x90 D 125x90 D 140x90 D 148x90	608,92 608,92 646,88 592,28 643,76 643,76 601,38 656,76	10 10 10 10 10 10 10 10	1,910 1,910 1,910 1,910 1,910 1,910 1,990 1,990



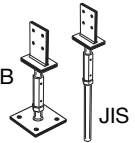
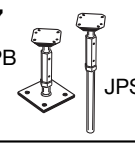
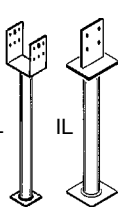
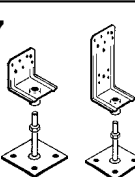
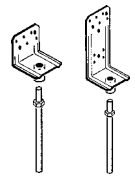
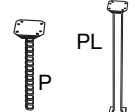

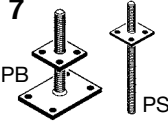
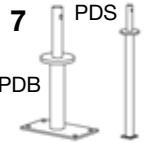

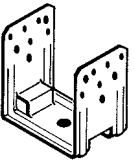
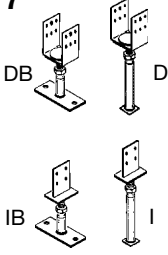

	Art. No.		CZK/ks	ks/bal.	kg/ks
<b>7</b> 	<b>Patka sloupku DK</b>				
	41446 01	DK 46x40	134,42	20	0,630
	41448 01	DK 48x40	134,42	20	0,630
	41450 00	DK 50x40	134,42	20	0,630
	41471 01	DK 71x40	139,10	20	0,660
	41473 01	DK 73x40	139,10	20	0,660
	41475 01	DK 75x40	139,10	20	0,660
	41070 01	DK 70x60	124,80	20	0,850
	41080 01	DK 80x60	126,62	20	0,850
	41090 01	DK 90x60	129,48	20	0,890
	41096 01	DK 96x60	127,92	20	0,890
	41098 01	DK 98x60	128,96	20	0,890
	41100 01	DK 100x60	143,78	20	0,890
41120 00	DK 120x60	160,42	20	1,020	
41140 00	DK 140x60	160,42	20	1,020	
<b>7</b> 	<b>Patka sloupku DKS, DKB</b>				
	41248 01	DKS 48x40	608,92	10	1,070
	41298 01	DKS 98x60	653,64	10	1,310
	41348 01	DKB 48x40	757,12	10	1,060
41398 01	DKB 98x60	795,08	10	1,300	
<b>7</b> 	<b>Patka sloupku DL</b>				
	42205 00	75x60	303,16	15	1,220
42210 00	100x60	309,14	15	1,260	
<b>7</b> 	<b>Patka sloupku I</b>				
26000 00	I	503,88	10	1,600	
<b>7</b> 	<b>Patka sloupku IS, IS MAXI</b>				
	31965 00	IS	831,22	8	2,250
31975 00	IS Maxi	2331,94	1	5,350	
<b>7</b> 	<b>Patka sloupku ISB, ISB MAXI</b>				
	31960 00	ISB 160	1027,78	5	2,860
	31970 00	ISB 260	1286,22	4	3,710
31980 00	ISB Maxi	2812,68	1	8,080	
<b>7</b> 	<b>Patka sloupku JDB</b>				
JDB18G	JDB18G (NOVINKA)	1007,76	10	2,110	

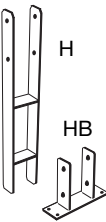







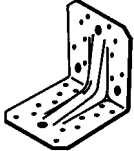
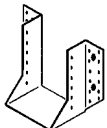

	Art. No.		CZK/ks	ks/bal.	kg/ks
<b>7</b>  JGB      JGS	<b>Patka sloupku JGB, JGS</b>				
	JGB18G JGS30G	JGB18G (NOVINKA) JGS30G (NOVINKA)	897,52 730,08	10 10	1,700 1,650
<b>7</b>  JIB      JIS	<b>Patka sloupku JIB, JIS</b>				
	43000 01 43001 01	JIB JIS	1183,52 1079,52	5 4	2,400 1,900
<b>7</b>  JPB      JPS	<b>Patka sloupku JPB, JPS</b>				
	43010 01 43011 01	JPB JPS	1354,08 1250,34	5 10	1,900 1,400
<b>7</b>  L      IL	<b>Patka sloupku L, IL</b>				
	31807 00	L 80x70	694,98	10	1,940
	31107 00	L 100x70	700,70	5	2,000
	31909 00	L 90x90	798,72	5	2,330
	31109 00	L 100x90	798,72	5	2,330
	31120 00	L 120x90	779,74	5	2,330
	31140 00 31000 00	L 140x90 IL	798,72 862,94	5 10	2,400 1,920
<b>7</b> 	<b>Patka sloupku LB</b>				
	40405 00	LB 60x65	528,84	10	0,790
	40410 00	LB 60x165	563,42	10	1,050
	40420 00 40430 00	LB 80x90 LB 80x190	543,92 578,50	10 10	0,900 1,100
<b>7</b> 	<b>Patka sloupku LS</b>				
	40305 00	LS 60x65	430,30	10	0,700
	40310 00	LS 60x165	463,58	10	0,920
	40320 00 40330 00	LS 80x90 LS 80x190	445,38 479,44	10 10	0,800 1,000
<b>7</b>  P      PL	<b>Patka sloupku P, PL</b>				
	43020 01 43021 01	P PL	687,70 889,72	15 10	1,100 1,550

	Art. No.		CZK/ks	ks/bal.	kg/ks
<b>7</b> 	<b>Patka sloupku PB, PS</b>				
	40600 01	PB 70	288,08	20	0,650
	40603 01	PB 75	287,56	20	0,910
	40605 00	PB 80	516,62	10	1,850
	40610 00	PS 80	470,86	10	1,200
<b>7</b> 	<b>Patka sloupku PDB, PDS</b>				
	PDB17G	PDB17G (NOVINKA)	748,54	10	1,720
	PDB27G	PDB27G (NOVINKA)	717,60	10	1,970
	PDS50G	PDS50G (NOVINKA)	761,54	8	1,930
<b>7</b> 	<b>Patka sloupku PGS</b>				
	PGS24/130	PGS24/130	919,36	6	2,650
	PGS24/180	PGS24/180	947,44	6	2,800
	PGS24/230	PGS24/230	986,44	6	3,070
	PGS24/280	PGS24/280	1042,86	6	3,250
<b>7</b> 	<b>Patka sloupku PPA, PPRC</b>				
	40810 01	PPA100	592,54	10	1,110
	40815 01	PPA150	625,30	10	1,300
	PPRC	PPRC	868,66	10	1,500
<b>7</b>	<b>Patka sloupku TB</b>				
	40700 01	TB 48x60	491,14	10	1,020
<b>7</b> 	<b>Patka sloupku U</b>				
	40005 00	U70	168,74	20	0,690
	40030 00	U80	168,74	20	0,690
	40040 00	U90	175,24	20	0,730
	40050 00	U100	175,24	20	0,730
	40060 00	U120	193,18	20	0,730
	40070 00	U140	193,18	20	0,730
	<b>7</b> 	<b>Patka sloupku VARIO</b>			
31950 00		D 80	1175,72	10	2,050
31948 00		D 120	1197,56	10	2,170
31951 00		DB 80	1270,10	8	2,510
31949 00		DB 120	1323,14	5	2,620
31952 00		Vario I	894,66	10	1,330
31953 00		Vario IB	1000,48	10	1,790
		výškově nastavitelná			

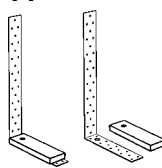

	Art. No.		CZK/ks	ks/bal.	kg/ks
<b>7</b> 	<b>U-kotva</b>				
	29045 00	45x127	118,04	25	0,500
	29050 00	50x125	118,04	25	0,500
	29060 00	60x120	118,04	25	0,500
	29070 00	70x115	118,04	25	0,500
	29080 00	80x110	118,04	25	0,500
	29090 00	90x115	122,46	25	0,540
	29100 00	100x110	122,46	25	0,540
29120 00	120x110	128,70	25	0,570	
<b>7</b> 	<b>Základní deska kotvy tvaru U</b>				
	29900 00	42x27	52,26	25	0,140
	29905 00	47x25	52,26	25	0,140
	29910 00	57x20	52,26	25	0,140
	29915 00	67x25	55,38	25	0,180
	29950 00	77x20	55,38	25	0,180
	29960 00	87x25	60,32	25	0,210
	29970 00	97x20	60,32	25	0,210
29990 00	117x20	66,04	25	0,240	
<b>7</b> 	<b>Sloupková kotva do betonu</b>				
	17730 01	300	83,46	25	0,350
	17735 01	350	112,06	25	0,410
	17745 01	450	176,28	25	0,710
<b>7</b> 	<b>Sloupkový bodec</b>				
	49305 01	50x50x750	308,10	1	1,120
	49307 01	50x75x750	309,14	1	1,740
	49310 01	50x100x750	373,10	1	2,040
	49391 01	90x90x750	351,26	1	2,390
	49390 01	90x90x900	393,38	1	2,740
	49375 01	70x70x750	311,22	1	1,880
	49320 01	75x75x750	350,74	1	2,010
	49330 01	100x100x750	410,28	1	2,640
	49038 01	Ø38x380	417,04	15	1,000
<b>7</b> PPJRB  PPJRE	<b>Sloupkový bodec PPJ</b>				
	PPJRB80	PPJRB80	277,42	10	1,050
	PPJRB100	PPJRB100	289,38	10	1,150
	PPJRE80/750	PPJRE80/750	473,46	10	1,450
	PPJRE100/750	PPJRE100/750	503,62	10	2,000

	Art. No.		CZK/ks	ks/bal.	kg/ks
	<b>Sloupková kotva H a HB</b>				
	49009 01	H 90	560,82	1	3,900
	49010 01	H 100	591,76	1	3,960
	49012 01	H 120	622,70	1	4,080
	49107 01	HB 70	233,48	1	1,360
	49109 01	HB 90	233,48	1	1,360
	49110 01	HB 100	233,48	1	1,360
49112 01	HB 120	233,48	1	1,360	
	<b>Plotové kování CP</b>				
	CP	CP	57,20	150	0,050
	<b>HE-kotva</b>				
	16002 00	135	34,32	100	0,150
	16001 01	175	37,70	100	0,180
	<b>Profilová kotva</b>				
	16100 00	2815-108	25,48	100	0,080
	16120 00	2815-158	30,16	100	0,120
	16140 00	2815-198	37,44	100	0,150
	16200 00	3817-159	33,54	100	0,160
	<b>Úhelník schodový TA</b>				
	TA9Z	TA9Z	80,34	50	0,290
	TA10Z	TA10Z	96,20	50	0,340
	<b>DBT1T podlahová spojka (pro terasy)</b>				
	DBT1T	DBT1T	1394,12*	100	1,900
	* Kyblík obsahující 100 ks včetně hřebíků k vodorovnému upevnění				
	<b>Čelní spojky</b>				
	14200 00	200	55,90	25+25	0,260
	14260 00	260	86,84	25+25	0,330
	Balení pravé/levé				
	<b>SRD/SRC</b>				
	SRC	SRC	138,32	20	0,180
	SRD	SRD	83,20	20	0,150
	SRR	SRR	184,08	20	0,210
	<b>Konzolové úhelníky CF-R, SBV</b>				
	CF-R	CF-R	82,16	25	0,160
	SBV	SBV	102,44	24	0,400



	Art. No.		CZK/ks	ks/bal.	kg/ks
<b>V4A - SPOJKY DO DŘEVA - NEREZ/INOX</b>					
<b>10</b> 	<b>Úhelník - Nerez/INOX</b>				
	07070 80	R70 se žebrem	126,62	100	0,110
	07090 80	R90 se žebrem	193,18	50	0,200
	07105 80	R105 se žebrem	352,82	50	0,380
	07071 80	R70 bez žebra	139,10	100	0,110
	07091 80	R90 bez žebra	206,18	100	0,200
	07106 80	R105 bez žebra	386,62	50	0,380
	AC35350S	R35350	89,70	100	0,050
	07390 80	R40390	164,06	100	0,160
	07365 80	R55365	150,54	100	0,150
08666 80	R60x60x2,5x60	169,26	100	0,140	
<b>10</b> 	<b>Trámová botka - Nerez/INOX</b>				
	03112 80	R60x100**	277,68	1	0,270
	03221 80	R80x120**	345,28	1	0,380
	03318 80	R100x140**	435,50	1	0,430
	03421 80	R120x160**	522,34	1	0,580
	03521 80	R140x180**	582,66	1	0,650
** livrabil în termen scurt					
<b>10</b> 	<b>Spojka vaznice-krokev - Nerez/INOX</b>				
	02170 80	R 170 levá	134,94	100	0,100
	02210 80	R 210 levá	177,58	100	0,130
	02171 80	R 170 pravá	134,94	100	0,100
	02211 80	R 210 pravá	177,58	100	0,130
<b>10</b> 	<b>Děrované pásy - Nerez/INOX</b>				
	27110 80	R 20x1,0 10 m	1479,40	10	1,530
<b>10</b> 	<b>Zavětrovací pásy - Nerez/INOX</b>				
	27419 80	R 40x2,0 25 m	13588,64	1 Rl.	15,000

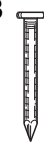

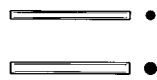
	Art. No.		CZK/ks	ks/bal.	kg/ks
<b>11</b> 	<b>Tažná kotva včetně podložky</b>				
	10405 00	340-M12	466,44	10	1,280
	10410 00	400-M16	525,72	10	1,230
	10415 00	420-M16	737,10	8	2,440
	10420 00	420-M20	525,72	10	1,220
	10425 00	480-M20	674,96	10	1,840
<b>11</b> 	<b>Tažná kotva HTT, LTT</b>				
	HTT16	HTT16	519,22	10	1,000
	HTT22	HTT22	630,76	10	1,200
	LTT20B	LTT20B	315,64	10	0,750
<b>11</b> 	<b>HD2P Tažná kotva 2-dílné</b>				
	HD2P60G-B	220-F	525,72	10	1,500
	HD2P40G	163-F	598,52	10	0,850
	HD2PL40G	379-F	856,96	5	1,800
	HD2PSG	163-S	908,44	10	1,500
	HD2PLSG	379-S	1175,20	5	2,500
	07003 00	U-podložka 50x50x8 Ø 18	61,10	50	0,160
	07002 00	U-podložka 40x50x10 13,5/25	61,10	50	0,160
	95022 00	E-JOT šrouby JT2-3/5,5x25	772,72*	100	0,62*
	* za 100 ks				
<b>11</b> 	<b>Kotva do betonu</b>				
	17200 00	200x2,0	26,52	150	0,120
	17300 00	300x2,0	36,40	100	0,180
	17400 00	400x2,0	55,38	80	0,230
	17500 00	500x2,0	79,56	50	0,300
	17600 00	600x2,0	93,86	50	0,350
	17204 00	200x4,0	58,50	75	0,250
	17304 00	300x4,0	89,70	50	0,380
	17404 00	400x4,0	107,12	40	0,500
	17504 00	500x4,0	142,22	25	0,630
	17604 00	600x4,0	160,42	25	0,760





13	CNA Kotevní hřebíky								
	Art. No. původní č. položky	Art. No. nové č. položky	Rozměry	CZK/bal.	ks/bal.	ks/kart.	bal./pal.	ks/pal.	kg/bal.
	99610 20	CNA6,0x100	6,0x100	998,40	250	250	80	20.000	5,99
	99680 20	CNA6,0x80	6,0x80	780,26	250	250	80	20.000	4,81
	99660 20	CNA6,0x60	6,0x60	603,20	250	250	80	20.000	3,78
	99410 00	CNA4,0x100	4,0x100	466,18	250	2000	320	80.000	2,67
	99475 00	CNA4,0x75	4,0x75	213,72	250	3000	480	120.000	2,08
		CNA4,0x60	4,0x60	181,74	250	3000	480	120.000	1,71
		CNA4,0x50	4,0x50	162,50	250	3000	480	120.000	1,38
	99440 00	CNA4,0x40	4,0x40	117,78	250	3000	480	120.000	1,12
	99435 00	CNA4,0x35	4,0x35	195,52	250	3000	480	120.000	1,03
	99375 00	CNA3,7x50	3,7x50	362,96	250	3000	480	120.000	1,25
	99346 00	CNA3,4x60	3,4x60	255,58	250	3000	480	120.000	1,18
	99316 00	CNA3,1x60	3,1x60	226,20	250	3000	480	120.000	1,00
	99314 00	CNA3,1x40	3,1x40	329,16	500	6000	480	240.000	1,34
	99312 00	CNA3,1x22	3,1x22	263,90	500	6000	480	240.000	0,84
	99286 00	CNA2,8x60	2,8x60	195,78	250	3000	480	120.000	0,83
13	CNA Kotevní hřebíky - Nerez/INOX								
Art. No. původní č. položky	Art. No. nové č. položky	Rozměry	CZK/bal.	ks/bal.	kg/bal.				
99660 80	CNA6,0x60S	R6,0x60	2514,98	100	1,53				
99460 80	CNA4,0x60S	R4,0x60	2504,32	250	1,71				
99450 80	CNA4,0x50S	R4,0x50	2390,44	250	1,40				
99440 80	CNA4,0x40S	R4,0x40	1882,66	250	1,13				
13	Hřebíky do krokví - pozinkované								
Art. No.	Rozměry	CZK/za 100 ks	ks/bal.	kg/bal.					
96680 20	6,0x80	364,00	500	9,800					
96611 20	6,0x110	494,00	500	13,400					
96615 20	6,0x150	572,00	500	18,100					
96618 20	6,0x180	910,00	250	11,090					
96621 20	6,0x210	1066,00	250	12,900					
96623 20	6,0x230	1274,00	250	14,150					
96626 20	6,0x260	1456,00	125	8,020					
96628 20	6,0x280	1612,00	125	8,610					
96630 20	6,0x300	1742,00	125	9,210					
96633 20	6,0x330	2080,00	125	10,450					
96636 20	6,0x360	2756,00	125	10,610					

13		<b>SST-hřebíky (Tvarovky EWP)</b>						
		<b>Art. No.</b>	<b>Rozměry</b>	<b>CZK/bal.</b>	<b>ks/bal.</b>	<b>ks/kart.</b>	<b>ks/pal.</b>	<b>kg/bal.</b>
		N10D	3,8x38	237,64	150	3750	120.000	0,600
13		<b>CSA Šrouby (vruty)</b>						
		<b>Art. No. původní č. položky</b>	<b>Art. No. nové č. položky</b>	<b>Rozměry</b>	<b>CZK/bal.</b>	<b>ks/bal.</b>	<b>ks/kart.</b>	<b>kg/bal.</b>
		95430 00	CSA4,0x30	4,0x30	374,92	250	1500	0,760
		95525 00	CSA5,0x25	5,0x25	398,58	250	1500	0,630
		95535 00	CSA5,0x35	5,0x35	433,94	250	1500	0,940
			CSA5,0x40	5,0x40	469,82	250	1500	0,980
			CSA5,0x50DE	5,0x50	578,50	250	1500	1,150
		<b>CSA Šrouby (vruty) - Nerez/INOX (V2A/AISI 304)</b>						
		95525 80	CSA5,0x25S	R5,0x25(V2A)	1677,78	250	1500	0,630
		95535 80	CSA5,0x35S	R5,0x35(V2A)	1824,42	250	1500	0,940
95540 80	CSA5,0x40S	R5,0x40(V2A)	1889,68	250	1500	0,980		
13	<b>SPAX® šrouby (s vrstvou dacromet)</b>							
	<b>Art. No.</b>			<b>CZK/bal.</b>	<b>ks/bal.</b>	<b>kg/ks</b>		
	95560 00	SPAX® šrouby 6x60 pro patka sloupku P / PL		1098,24	200	1,600		
	95570 00	SPAX® šrouby 5x70 pro EL		960,96	200	1,300		
	95580 00	SPAX® šrouby 5x80 pro ET		1098,24	200	1,450		
13		<b>Kolíky - žárově zinkované</b>						
		STD8x45G-B	8x45		13,26	100	0,020	
		STD8x65G-B	8x65		15,86	100	0,030	
		STD8x80G-B	8x80		16,38	100	0,030	
		STD8x90G-B	8x90		17,16	100	0,040	
		STD8x100G-B	8x100		18,20	100	0,040	
		STD8x115G-B	8x115		18,72	100	0,050	
		STD8x120G-B	8x120		18,98	100	0,050	
		STD8x140G-B	8x140		23,14	100	0,060	
		STD12x65G-B	12x65		27,30	100	0,060	
		STD12x80G-B	12x80		33,54	100	0,070	
		STD12x90G-B	12x90		34,84	100	0,080	
		STD12x100G-B	12x100		35,62	100	0,090	
		STD12x115G-B	12x115		39,52	100	0,100	
		STD12x120G-B	12x120		40,82	100	0,110	
		STD12x140G-B	12x140		44,46	100	0,120	



	Art. No.		CZK/ks	ks/bal.	kg/ks
<b>13</b>  	<b>Kolíky - galvanické pozinkování, žluté chromátování</b>				
	STD6x66-B	6x66	10,14	100	0,010
	STD8x45-B	8x45	11,18	100	0,020
	STD8x60-B	8x60	12,48	100	0,020
	STD8x65-B	8x65	12,74	100	0,030
	STD8x70-B	8x70	13,26	100	0,030
	STD8x80-B	8x80	13,78	100	0,030
	STD8x90-B	8x90	14,30	100	0,040
	STD8x100-B	8x100	15,34	100	0,040
	STD8x115-B	8x115	16,12	100	0,050
	STD8x120-B	8x120	16,12	100	0,050
	STD8x140-B	8x140	18,72	100	0,060
	STD8x160-B	8x160	21,32	100	0,060
	STD10x90-B	10x90	20,54	100	0,060
	STD10x100-B	10x100	24,44	100	0,060
	STD10x120-B	10x120	25,48	100	0,070
	STD10x140-B	10x140	29,38	100	0,090
	STD12x60-B	12x60	23,92	100	0,050
	STD12x65-B	12x65	23,14	100	0,060
	STD12x80-B	12x80	27,56	100	0,070
	STD12x90-B	12x90	29,38	100	0,080
	STD12x100-B	12x100	29,64	100	0,090
	STD12x110-B	12x110	31,98	100	0,100
	STD12x115-B	12x115	33,02	100	0,100
	STD12x120-B	12x120	33,80	100	0,110
	STD12x130-B	12x130	35,62	100	0,110
	STD12x140-B	12x140	37,18	100	0,120
	STD12x160-B	12x160	39,00	100	0,150
	STD12x180-B	12x180	43,68	100	0,150
	STD12x200-B	12x200	50,44	100	0,160
	STD16x120-B	16x120	48,62	50	0,220
	STD16x140-B	16x140	57,20	50	0,230
STD16x150-B	16x150	60,58	50	0,240	
STD16x160-B	16x160	64,48	50	0,300	
STD16x180-B	16x180	73,06	50	0,310	
STD16x200-B	16x200	81,12	50	0,320	
STD16x250-B	16x250	101,14	50	0,400	
STD20x200-B	20x200	124,80	25	0,500	
STD20x250-B	20x250	149,76	25	0,620	
<b>13</b>  	<b>U-podložka, žárově zinkované</b>				
	07001 00	40x40x10 Ø 13,5	52,26	50	0,130
	07003 00	50x50x8 Ø 18	61,10	50	0,160
	07002 00	40x50x10 Ø 13,5/25	61,10	50	0,160
	07006 00	60x60x6 Ø 14	61,88	50	0,130

	Art. No.		CZK/ks	ks/bal.	kg/ks
 oboustranné	<b>BULLDOG® , Spojky do dřeva oboustranné ozubení</b>				
	80200 00	D50A-VZ	13,52	200	0,020
	80201 00	D62A-VZ	21,58	100	0,030
	80202 00	D75A-VZ	26,00	100	0,050
	80210 00	D50F-VZ	14,56	200	0,020
	80220 00	D62F-VZ	22,88	100	0,040
	80230 00	D75F-VZ	30,16	100	0,050
	80240 00	D95F-VZ	55,64	40	0,090
	80250 00	D117F-VZ	92,04	25	0,160
	80260 00	D100x100F-VZ	66,56	50	0,110
	80270 00	D130x130F-VZ	149,76	25	0,210
	80280 00	D73x130F-VZ	76,44	50	0,110
	80290 00	D140x60 (NOVINKA)	271,44	25	0,220
	80295 00	D165x70 (NOVINKA)	321,36	25	0,360
	 jednostranné	<b>BULLDOG® , Spojky do dřeva jednostranné ozubení</b>			
80005 00		E50M10	14,04	300	0,020
80010 00		E50M12*	14,04	300	0,020
80020 00		E50M16	14,04	300	0,020
80025 00		E50M20	14,04	300	0,020
80030 00		E62M12*	22,88	150	0,040
80040 00		E62M16	22,88	150	0,030
80050 00		E62M20	22,88	150	0,030
80055 00		E75M12	29,64	100	0,050
80060 00		E75M16*	29,64	100	0,050
80070 00		E75M20	29,64	100	0,050
80071 00		E75M22	29,64	100	0,050
80072 00		E75M24	29,64	100	0,050
80080 00		E95M16*	54,34	50	0,090
80081 00		E95M20	54,34	50	0,080
80082 00		E95M22	54,34	50	0,080
80083 00		E95M24	54,34	50	0,080
80090 00		E117M16	89,18	40	0,150
80100 00		E117M20*	89,18	40	0,150
80105 00		E117M22	89,18	40	0,140
80110 00		E117M24	89,18	40	0,140
80115 00		E117M26	89,18	40	0,140
80135 00		E73X130M20	78,52	50	0,110
80145 00	E73X130M24	78,52	50	0,110	
* Nejmenší průměr čepů dle normy DIN 1052					

	Art. No.		CZK/ks	ks/bal.	kg/ks
<b>13</b> 	<b>Kruhový klínový hmoždík Appel, oboustranné</b>				
	80460 00	AD0 (65 mm)	73,58	150	0,060
	80461 00	ADI (80 mm)	83,46	100	0,080
	80462 00	ADII (95 mm)	89,70	100	0,100
	80463 00	ADIII (126 mm)	130,26	50	0,130
	80464 00	ADIIIa (128 mm)	197,60	25	0,280
	80465 00	ADIV (160 mm)	296,92	25	0,340
	80466 00	ADV (190 mm)	395,72	20	0,500
<b>13</b> 	<b>Kruhový klínový hmoždík Appel, jednostranné</b>				
	80450 00	AE0/2M12 (65 mm)	89,70	200	0,050
	80451 00	AEI/2M12 (80 mm)	130,26	100	0,090
	80452 00	AEII/2M12 (95 mm)	154,96	100	0,130
	80453 00	AEIIIa/2M12 (128 mm)	271,44	50	0,300
	80454 00	AEIV/2M16 (160 mm)	339,56	20	0,500
	80455 00	AEV/2M16 (190 mm)	457,34	20	0,750
<b>13</b> 	<b>Vtlačitelný hmoždík GEKA, oboustranné ozubení</b>				
	80412 00	TD50	21,58	400	0,050
	80414 00	TD65	36,66	150	0,090
	80416 00	TD80	52,00	150	0,110
	80418 00	TD95	68,38	100	0,140
	80420 00	TD115	96,20	75	0,190
<b>13</b> 	<b>Vtlačitelný hmoždík GEKA, jednostranné ozubení</b>				
	80402 00	TE50M12	21,58	400	0,060
	80404 00	TE65M16	35,62	200	0,090
	80406 00	TE80M20	54,08	200	0,130
	80408 00	TE95M24	71,76	150	0,170
	80410 00	TE115M24	109,72	75	0,250
<b>15</b> 	<b>KOLLIBRODD Load Stopper</b>				
	85000 00	Skin 1 (Ø 50)	29,90	300	0,030
	85001 00	Skin 2 (Ø 62)	33,28	300	0,040
	85002 00	Skin 3 (Ø 75)	40,30	200	0,060
	85003 00	Skin 4 (Ø 95)	58,50	100	0,100
	85005 00	Skin 8 (48x65 mm)	31,20	300	0,040
	85006 00	Nebalený 1 (Ø 50)	15,08	200	0,020
	85007 00	Nebalený 2 (Ø 62)	17,68	100	0,030
	85011 00	Nebalený 8 (48x65 mm)	16,12	100	0,030

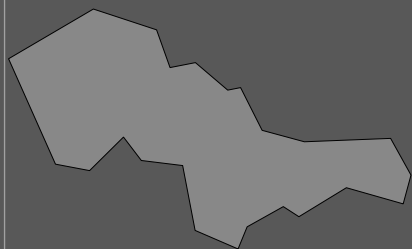

## **SIMPSON STRONG-TIE® s.r.o.**

Kyjovská 3280, CZ-580 01 Havlíčkův Brod  
Česká Republika

Tel: +420 569433555

Fax: +420 569433561

[info@strongtie.cz](mailto:info@strongtie.cz)

[www.strongtie.cz](http://www.strongtie.cz) · [www.strongtie.eu](http://www.strongtie.eu)